

# Filter World We focus



SHANGHAI THENOW TECHNOLOGIES CO.,LTD.

Catalogue 



SHANGHAI THENOW TECHNOLOGIES CO.,LTD.,established in 2005,belongs to Apureda International (Group) Co.,Ltd.,as the wholly-owned subsidiary. APD is a high technology filter manufacturer and supply filter products with distributors and OEM all over the world. Products including:purification products on compressor,compressed air purification,dust removal equipments,construction machinery, building machinery,transport machinery and so on.

APD's filtration business division--THENOW TECHNOLOGIES always committed to providing high quality air filtration products,and is able to supply air dust filtration solutions which adapt to different dust for a wide range of industrial,dust including: grinding,toxic,explosive. We concentrate on the fields like cement,metallurgy/aluminum,food&beverage,wood,chemical,power coating,plasma/laser cutting,sand blasting,textile,welding,casting and so on.Besides, OEM is also welcome here.

As an industry standard-setter, Thenow aims to create the high quality filtration products which can meet customer demand, continue to develop innovative filtration products, improve product performance, meantime, try our best to reduce the cost and create maximum value for our customers.



## Filter Element

# KAESER

Model	Description	Genuine P/N	THENOW P/N
AT11	Air Filter	6.0215.0	32 114 10 073
	Air Filter	6.2084.0	32 113 15 342
AT36	Air Filter	6.2055.0/A1	32 114 12 175
	Air Filter	6.1994.0	32 111 13 217
	Air Filter	6.3564.0	32 113 22 370
	Air Filter	6.4143.0	32 114 30 083
	Air Filter	6.1995.0	32 111 30 461
	Air Filter	6.2183.0	32 113 29 560
	Air Filter	6.2003.0	32 114 11 180
	Air Filter	6.4139.0	32 111 32 095
	Oil Filter	6.3463.0	AO 0924
	Oil Filter	6.3464.1/B1	AO 0928
AT36(30HP)	Oil Filter	6.1985.1	AO 0905
	Oil Filter	6.1981.1	AO 0901
	Oil Filter	6.1979.0	AO 1301
	Air Oil Separator	6.2011.1	32 211 17 242
	Air Oil Separator	6.3535.0	32 211 39 397
DSD-241	Air Oil Separator	6.2008.1	32 211 14 200
	Air Oil Separator	6.2134.0	32 211 40 513
7.5kw	Air Oil Separator	6.2024.0	32 213 08 158
	Air Oil Separator	6.3559.0	32 211 40 605
	Air Oil Separator	6.3569.0	32 211 22 270
	Air Oil Separator	6.1893.0/A1	32 213 08 160
	Air Oil Separator	6.1931.1/A1	32 211 14 200
	Air Oil Separator	6.3571.0	32 211 22 381
	Air Oil Separator	6.1968.0	32 211 13 198
	Air Oil Separator	6.3671.0/G2	32 211 13 230
BS61(50HP)	Air Oil Separator	6.3566.0/G1	32 211 15 305
	Air Oil Separator	6.2012.1	32 211 16 434
	Air Oil Separator	6.1965.0	32 211 27 762



# Air Oil Separator

# COMPAIR

Model	Flow Rate m <sup>3</sup> /min	Original P/N	Outside mm	Height mm	THENOW P/N
L37/L75	6-14	10525274	135	302	AA1355
L90/L110	5-19	10882574	350	400	32 211 30 402
L132/L160	20-29	11427274	439	350	32 211 35 350
L200/L250	30-43	11427474	439	490	32 212 39 490
822/830/837 PUAS	3.5-5.6	59180	70	255	32 215 70 255
RALLYE 070-112	7.1-12/7.5	10525274	135	302	AA 1355
6050N	6.3/0.75	98262/194	200	250	32 211 17 250
6075N	10/0.7	98262/162	274	230	32 211 22 230
6100N	13.5/0.7	98262/26	348	450	32 211 30 450
6150N	20/0.7	98262/78	355	600	32 211 30 603
Sirius250	42.7/0.7	11427474	440	490	32 211 39 490

### Specifications:

Oil Residual Content after Separation  $\leq$  3ppm w/w  
 Service Life : 4000h

Initial differential pressure  $\leq$  0.02MPa





# Air Filter

# COMPAIR

Model	Flow Rate m <sup>3</sup> /min	Original P/N	Outside mm	Height mm	THENOW P/N	Remarks
707PUAS	1.25/0.7	50273	260	82	32 114 26 082	Plastic Glued Cover
715PUAS	2.25/0.8					
822PUAS	3.57/0.8	50332	350	77	32 114 35 077	Plastic Glued Cover
830PUAS	4.56/0.8	52438	350	104	32 114 35 104	Plastic Glued Cover
837PUAS	5.64/0.8					
RALLYE 070-112	7.1-12/7.5	29504376	195	370	32 113 19 370	Plastic Glued Cover
6050N	6.3/0.75	C11158/1014(98262/163)	165	338	32 111 16 338	
6075N	10/0.7	98262/170	198	361	32 111 19 361	
6150N	20/0.7	C11158/1390	243	481	32 111 24 481	
Sirius 250	42.7/0.7	06296777	328	605	32 111 32 605	

**Specifications:** Filtration Precision: 3µm-12µm Service Life: 2000h

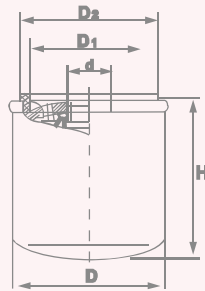

# Oil Filter

# COMPAIR

Model	Flow Rate m <sup>3</sup> /min	Original P/N	D mm	H mm	d	D1 mm	D2 mm	THENOW P/N
715PUAS	2.25/0.8	56457	94	97	3/4-16UNF	62	72	AO 0908
822PUAS	3.57/0.8	57562	94	144	1-12UNF	62	72	AO 0904
830PUAS	4.65/0.8							
837PUAS	5.64/0.8	59946	108	225	1-12UNF	62	72	AO 1005
RALLYE 070-112	7.1-12/7.5	04425274	135	302	1 1/2-16UNF	100	110	AO 1309
6100N、6150N 6180N、6220N	13.5、20、26/0.7	98262/219	108	260	1 1/8-16UNF	94	104	AO 1001
Sirius 250	42.7/0.7	04425274	135	302	1 1/2-16UNF	100	110	AO 1309

**Specifications:** Filtration Precision: 5µm-12µm Initial differential pressure: ≤0.03MPa  
Max Working Pressure: 1.4MPa-2.5MPa Service Life: 2000h



# Air Filter

# ATLASCOPCO

Model	Original P/N	OD mm	Height mm	THENOW P/N	Remarks
GA11	1613872000	119	134	32 114 11 134	Plastic Glued Cover
GA18	1619126900	138	115	32 114 13 115	Plastic Glued Cover
GA22	1613872000	119	134	32 144 11 134	Plastic Glued Cover
GA30	1613740700	159	375	32 113 15 342	Plastic Glued Cover
GA37	1613740800(2901043100)	194	407	32 113 19 370	Plastic Glued Cover
GA55	1613950100	246	358	32 113 24 323	Plastic Glued Cover
	1603950300	246	410	32 113 24 370	Plastic Glued Cover
GA75	1613800400(2901043100)	220	406	32 113 22 370	Plastic Glued Cover
	1619279800(290100500)	230	370	32 113 23 370	Plastic Glued Cover
GA90C					
GA110	1030097900	350	345	32 111 35 345	
GA132	(2906009200)				
GA160	1621054799				
GA220	1627009499	390	460	32 111 39 460	
GA250	1621054600				
	1030107000	300	108	32 114 30 108	Plastic Glued Cover

**Specifications:** Filtration Precision: 3 $\mu$ m-12 $\mu$ m    Service Life: 2000h



# Air Oil Separator

# ATLASCOPCO

Model	Original P/N	Flange mm	Height mm	THENOW P/N
GA18	1612386900	220	250	32 211 13 251
GA22	1613750200(2901034300)	240	175	32 211 13 175
GA30	1622007900	203	139	32 211 13 139
GA37	1613243300	300	300	32 211 17 301
GA45	1613688000(2901021300)	299	230	32 211 17 231
GA45	1613839700(2901056600)	298	177	32 211 17 177
GA75	1613730600(2901007000)	300	350	32 211 21 351
GA75	1613800700(2901043200)	400	300	32 211 23 301
GA75	1613955900 1613984000	364	274	32 211 22 274
GA90C	1614642300(2906009800)	500	450	32 211 35 450
GA110	1614905400(2906056400)	597	280	32 211 34 281
GA132/GA160	1614905600	597	350	32 211 35 351
GA160	1614642300	500	450	32 211 35 451
GA220	1614704800(2906020200)	500	600	32 211 40 601

### Specifications:

Oil Residual Content after Separation  $\leq$  3ppm w/w Initial differential pressure  $\leq$  0.02MPa  
 Service Life : 4000h

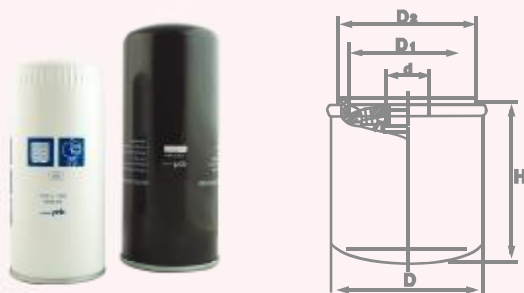

# Oil Filter

# ATLASCOPCO

Original P/N	D mm	H mm	d	D1 mm	D2 mm	THENOW P/N
1613610500	94	212	1-12UNF	62	72	AO 0990
1614727300	108	260	1 $\frac{1}{8}$ -16UNF	94	104	AO 1001

**Specifications:** Filtration Precision : 5 $\mu$ m-12 $\mu$ m Initial differential pressure: 0.03MPa  
 Max Working Pressure:1.4MPa-2.5MPa Service Life:2000h



# Air Filter

# INGERSOLLRAND

Model	Flow Rate m <sup>3</sup> /min	Original P/N	OD mm	Height mm	THENOW P/N	Remarks
UPS22	3	89295976	119	134	32 114 11 134	Plastic Glued Cover
30S	3	42855429	138	123	32 113 13 123	Plastic Glued Cover
M22	3	42888214	200	76	32 112 20 076	
ML22	3	39588470	130	151	32 113 13 125	Plastic Glued Cover
50S	6	42855411	216	318	32 113 21 283	Plastic Glued Cover
ML37	6	39588777	130	276	32 113 13 250	Plastic Glued Cover
M37	6	99273906	270	120	32 112 27 120	
EP100	10	99267031	270	240	32 112 27 240	
M55	10	39708466	278	125	32 113 27 125	Plastic Glued Cover
75S	10	42855403	278	251	32 114 27 251	Plastic Glued Cover
VHP400SCU	11.6	92686948(main)	242	484	32 111 24 484	
		92686955(safety)	127	476	32 111 12 476	
EP200	20	99266702	270	370	32 112 27 370	
M90	20	39903281	380	178	32 113 38 178	Plastic Glued Cover
150S	20	39903281	380	178	32 112 38 178	
VHP700E	20	92035948(main)	300	460	32 111 30 460	
P1050E	29.5	92035955(safety)	150	468	32 111 15 448	
P600SCU	17	92686922(main)	225	372	32 111 22 372	
		92686930(safety)	109	376	32 111 10 358	
M250	40	42852129 39903265	380	362	32 114 38 362	Plastic Glued Cover
900		89288971(main)	295	583	32 113 29 560	Plastic Glued Cover
		89288969(safety)	192	573	32 113 19 573	Plastic Glued Cover

**Specifications:** Filtration Precision: 3μm-12μm    Service Life: 2000h





# Air Oil Separator

# INGERSOLLRAND

Model	Flow Rate m <sup>3</sup> /min	Original P/N	Flange mm	Height mm	THENOW P/N
UPS22	3	54749247		302	32 310 13 302
30S、ML22	3	39831888	194	226	32 212 17 226
M22	3	39751391	194	216	32 212 17 216
50S、M37	6	39831888	194	226	32 212 17 226
M37	6	92754688	194	232	32 212 17 232
EP100	10	42841239	336	356	32 212 22 356
75S、M55	10	39894597	300	190	32 212 27 190
75S	10	54601513	300	190	32 212 27 190
EP200	20	42841247	374	457	32 212 30 457
M90	20	54509427	374	457	32 212 30 458
150S	20	39863865	374	457	32 212 30 458
VHP400SCU	11.6				
P600SCU	17	92699198	305	250	32 212 27 250
P600SCA	23				
VHP700	29.5	92062132	440	620	32 211 40 620
P1050E					32 212 40 620
ML250	40	39831920	431	412	32 212 37 412
M250	40	54509500	431	444	32 212 37 444
		39890600			
		39863840	240	275	32 211 17 275

### Specifications:

Oil Residual Content after Separation  $\leq$  3ppm w/w Initial differential pressure  $\leq$  0.02MPa Service Life  $>$ 4000h

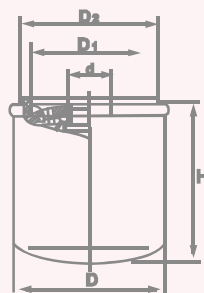

# Oil Filter

# INGERSOLLRAND

Model	Original P/N	D mm	H mm	d	D1 mm	D2 mm	THENOW P/N
USP22	54672654/B	94	212	1-12UNF	62	72	AO0999
ML22、30S、ML37、50S	39907175	94	212	1-12UNF	62	72	AO0998
M37、M22	42888198	94	212	1-12UNF	62	72	AO0997
M55	39911631	118	283	1 3/4-12UNF	74	88	AO1102
75S	42843797	135	200	M38x1.5	100	110	AO1304
150S	42843805	135	302	M38x1.5	100	110	AO1302
M90	39856836	118	283	1 3/4-12UNF	98	110	AO1103
ML250、M250	92888262	135	302	1 1/2-16UNF	100	110	AO1301
EP100、VHP400SCU	99270134	102	202	oil filter core			32 411 10 202
EP200、VHP700E	99274060	102	402	oil filter core			32 411 10 405
	92071132	108	260	1 1/8-16UNF	94 $\leq$	104	AO1001

**Specifications:** Filtration Precision: 5 $\mu$ m-12 $\mu$ m Initial differential pressure: 0.03MPa  
Max Working Pressure: 1.4MPa-2.5MPa Service Life: 2000h



# Air Filter

# SULLAIR

Model	Flow Rate m <sup>3</sup> /min	Original P/N	OD mm	Height mm	THENOW P/N	Remarks
LS-10-25	2.8	02250131-496	133	280	32 111 13 280	
LS-10-30	3.5	42445	198	110	32 112 19 100	
LS-10-40	4.4	40596(02250044-537)	154	305	32 111 15 305	
LS-12-50	6.1	02250131-498	174	407	32 111 17 407	External Core
LS-16-75	9.4	88290002-337	242	484	32 111 24 484	External Core
		88290002-338	127	476	32 111 12 476	Internal Core
LS-16-60		02250131-499			32 111 23 330	
LS-20-100	13.2	02250131-012	252	432	32 111 25 432	External Core
	14.4	02250131-013	144	392	32 111 14 392	Internal Core
LS-20-150	21	409853	290	395	32 111 29 395	External Core
		409854	175	356	32 111 17 356	Internal Core
LS-20-200	28.3	88290001-466	380	564	32 111 38 564	External Core
		88290001-467	240	480	32 111 24 480	
		88290003-111	415	450	32 111 35 450	Internal Core
		88290001-469	300	380	32 111 30 380	
LS-25-250	41.8	250007-838	350	736	32 111 35 736	External Core
LS-25-300	41.2	250007-839	250	705	32 111 25 705	Internal Core
LS-25-350		88290001-466	380	564	32 111 38 564	External Core
		88290001-467	240	480	32 111 24 480	
		88290003-111	415	450	32 111 35 450	Internal Core
		88290001-469	300	380	32 111 30 380	
		250018-652	230	330	32 111 23 330	
		88290004-372	415	640	32 111 41 640	

**Specifications:** Filtration Precision: 3μm-12μm    Service Life: 2000h



# Air Oil Separator

# SULLAIR

Model	Flow Rate m <sup>3</sup> /min	Original P/N	Flange mm	Height mm	THENOW P/N	Remarks
LS25/ LS40	2.8 4.4	250034-112 250034-114	200 200	172 245	32 211 17 173 32 211 17 245	
LS50/ LS60	6.1 7.6	250034-116 250034-862	270 270	405 360	32 212 21 405 32 211 10 360	External Core Internal Core
LS-20-100	13.2	02250061-137	270	405	32 212 21 405	External Core
	14.4	02250061-138	270	360	32 211 10 360	Internal Core
LS-20-150	21	250034-085	350	620	32 212 27 620	External Core
		02250048-734	350	460	32 211 14 460	Internal Core
LS250	41.8	250034-124	600	570	32 212 48 570	External Core
LS300		250034-130	600	430	32 212 27 430	Internal Core
LS350	41.2	250034-120	354	663	32 212 30 663	External Core
		250034-128	354	585	32 211 21 585	Internal Core

### Specifications:

Oil Residual Content after Separation  $\leq$  3ppm w/w Initial differential pressure  $\leq$  0.02MPa Service Life  $>$  4000h

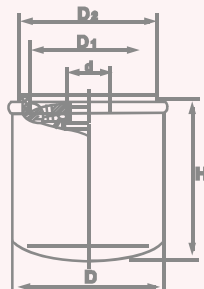

# Oil Filter

# SULLAIR

Model	Flow Rate m <sup>3</sup> /min	Original P/N	D mm	H mm	d	D1 mm	D2 mm	THENOW P/N
LS25/LS40	2.8-4.4	250025-525	118	155	1 $\frac{5}{8}$ -11	98	110	AO1104
LS50/LS150	6.1-21	250025-526	118	285	1 $\frac{5}{8}$ -11	98	110	AO1101
LS200/LS350	23-41	02500139-996	96	493	Oil Filter Core			32 411 09 493
LS250-300		250007-842	114	370				32 411 11 370

**Specifications:** Filtration Precision: 5 $\mu$ m-12 $\mu$ m Initial differential pressure:  $\leq$ 0.03MPa  
Max Working Pressure: 1.4MPa-2.5MPa Service Life: 2000h



# Gardner Denver

Model	Description	Genuine P/N	THENOW P/N
ES37,50HP	Air Filter	81166609	32 114 21 097
	Air Filter	03400158/5	32 113 15 342
	Air Filter	2116701	32 116 15 380
	Air Filter	85067179	32 111 35 357
30HP	Air Filter	85644309	32 114 20 075
	Air Filter	2116150	32 111 13 281
	Air Filter	2118349	32 113 31 510
ES37,50HP	Air Filter	2010509	32 111 28 408
	Oil Filter	89559379	AO 0918
	Oil Filter	89755919	AO 1007
	Oil Filter	89515869	32 411 79 200
	Oil Filter	2118345-P	32 411 08 300
	Oil Filter	89675429	AO 0900
ES37	Oil Filter	2118342-P	32 411 08 181
	Air Oil Separator	03267728	32 213 07 242
	Air Oil Separator	202ECH6013	32 214 14 309
	Air Oil Separator	208EAP6013	32 214 14 555
	Air Oil Separator	200ECM035	32 214 14 552
	Air Oil Separator	03340028	32 211 10 402
	Air Oil Separator	CC1053700	32 214 10 366
	Air Oil Separator	02250121-500	32 212 17 235
30HP	Air Oil Separator	208EAP6013	32 214 14 555
	Air Oil Separator	2116717	AA 1359
	Air Oil Separator	202EAU6013	32 214 24 766



# BOGE

Model	Description	Genuine P/N	THENOW P/N
S15,S20	Air Filter	569000901	32 112 09 105
S-30	Air Filter	569002811	32 113 11 220
S-50/S60	Air Filter	143000303	32 111 16 228
S-125,150	Air Filter	569000729	32 111 24 481
	Air Filter	569003401	32 113 12 288
	Air Filter	569000726	32 111 19 361
	Air Filter	569000729	32 111 24 486
	Air Filter	569004101	32 114 06 069
S15	Oil Filter	558000309	AO 0702
S-20	Oil Filter	558000307	AO 0908
S-75,S100	Oil Filter	558000303	AO 0905
S-125,150	Oil Filter	558000308	AO 1301
S-180/10	Oil Filter	558000308	AO 1301
S15	Air Oil Separator	575000102	AA 0710
S20	Air Oil Separator	575000103	AA 0920
S30	Air Oil Separator	575000105	AA 1330
S-50/S60	Air Oil Separator	575000101	AA 1360
	Air Oil Separator	575076301	32 213 08 126





# HITACHI

Model	Description	Genuine P/N	THENOW P/N
OSP-15UAR	Air Filter	P81-2709	3211117093
	Air Filter	P81-4457	3211117125
	Air Filter	P81-4459	3211117210
75 HP	Air Filter	P83-3928	3211119208
OSP-75	Air Filter	P81-4462	3211123255
75 HP	Air Filter	P81-2152	3211123332
	Air Filter	52302330	3211312303
	Air Filter	755423	3211206083
100HP	Air Filter	P81-2562	3211310264
	Oil Filter	55175910	AO0941
100HP	Oil Filter	55305910	AO0904
	Oil Filter	56645910	AO0939
OSP37S-5A/37M-5A	Air Oil Separator	52323020	3221110320
OSP37S-5AI/37M-5AI	Air Oil Separator	55303020	3221110320
	Air Oil Separator	52533020	3221108117
OSP 7.5E (10 HP)	Air Oil Separator	50513021	3221111130
OSP15E 5A (20 HP)	Air Oil Separator	50533021	3221113163
	Air Oil Separator	3422006800	3221127306
OSP15U-5A	Air Oil Separator	21114040	3221115140
OSP22U-5AI	Air Oil Separator	36014040	3221115252
OSP37U-5AI	Air Oil Separator	36214040	3221115303
OSP22UA	Air Oil Separator	21714040	3221117202
OSP37U-5A	Air Oil Separator	22114040	3221120201
OSP55U-5AI	Air Oil Separator	29414040	3221120251
OSP75U-5AI	Air Oil Separator	29614040	3221130304
OSP11S-5A/11M-5A	Air Oil Separator	52553020	3221308203
OSP22S-5AI/22M-5AI	Air Oil Separator	55173021	3221110254
OSP22S-5A/22M-5A	Air Oil Separator	52303020	3221110254



# Kobelco

Model	Description	Genuine P/N	THENOW P/N
KST37A/KST55	Air Filter	SCE05-507	32 113 23 331
	Air Filter	SCE05-504	32 113 18 389
	Air Filter	PCE05-532	32 111 20 130
	Air Filter	PCE05-516-01	32 112 14 224
	Air Filter	PF03-3010	32 112 20 303
	Air Filter	SCE05-505	32 113 23 468
New KST37	Air Filter	SCE05-501	32 113 10 264
	Air Filter	PF04-3001	32 112 30 303
	Air Filter (Outer)	SCE05-503	32 113 16 349
	Oil Filter	PCE13-528	AO 0919
	Oil Filter	PCE13-515	AO 0915
	Oil Filter	PCE13-526	AO 0936
20 HP	Oil Filter	P-CE13-517	AO 0937
	Oil Filter	PCE13-506	AO 1201
	Air Oil Separator	4A11L0100	32 211 09 091
	Air Oil Separator	PCE03-572	32 211 10 322
	Air Oil Separator	PCE03-525	32 211 12 148
	Air Oil Separator	PCE03-536	32 211 12 150
	Air Oil Separator	PCE03-578	32 211 13 299
	Air Oil Separator	PCE03-577	32 211 13 402
	Air Oil Separator	PCE03-555-04	32 211 11 282
	Air Oil Separator	PCE03-535	32 211 14 185
KST15	Air Oil Separator	PCE03-530	32 211 14 241
	Air Oil Separator	PCE03-537	32 211 15 215
	Air Oil Separator	PCE03-517	32 211 25 300
HM22A	Air Oil Separator	PF03-3025-01	32 213 12 197
	Air Oil Separator	4H11L01013P1	32 211 15 250
	Air Oil Separator	PCE03-542	32 211 34 513



# Mitsui- Seiki

Model	Description	Genuine P/N	THENOW P/N
	Air Filter	71127083801	32 111 20 255
	Air Filter	11282001-00	32 111 28 160
Z156A, Z225	Air Filter	71101083804	32 112 14 235
	Air Filter	7110341380100	32 112 28 180
	Air Filter	71103373801	32 112 28 150
	Air Filter	7110404380110	32 113 16 349
	Air Filter	71106403801	32 111 20 258
	Air Filter	7115166010	32 111 20 178
	Air Filter	7110337807400	AO 1002
	Oil Filter	7110345338000	AO 1004
	Oil Filter	72104040807	32 211 11 245
50-100 (NEW) block	Air Oil Separator	71100223945	32 211 17 122
	Air Oil Separator	72123020801	32 211 11 443
	Air Oil Separator	7110337394500	32 211 17 333
	Air Oil Separator	7110345394500	32 211 17 261
Z085, Z115	Air Oil Separator	71100043912	32 211 17 125
Z115A, Z225A	Air Oil Separator	71104503945	32 211 17 200
Z115A, Z225A	Air Oil Separator	71101163945	32 211 17 212
Z375A (NEW)	Air Oil Separator	71103453945	32 211 17 261
50 HP	Air Oil Separator	CH430802	32 211 17 311
Z375A	Air Oil Separator	71103373945	32 211 17 333
Z555A	Air Oil Separator	71106302532	32 211 25 301
Z755A	Air Oil Separator	71107312532	32 211 25 445
Z555A	Air Oil Separator	71106402545	32 211 34 310
Z755A	Air Oil Separator	71127082545	32 211 34 330
Z556A	Air Oil Separator	7110640254500	32 211 34 284
Z225A-S	Air Oil Separator	7212210080300	32 211 11 394
	Air Oil Separator	7135604392402	AA 0921



Filter  
Element

# SIRC

DP、GP、HE、AC	m <sup>3</sup> /min	DP
123	3.45	88343181
216	6.05	88343199
275	7.7	88343207
350	9.8	88344254
481	13.46	88343330
706	19.76	88343355
850	23.8	88343488
1100	30.8	88343496
1300	38.63	88343504



Filter  
Element

# Hankison

Model NO.	Flow m <sup>3</sup> /min
E9-16	1
E9-20	2
E9-24	3
E9-28	4.9
E9-32	7.2
E9-36	11
E9-40	14
E9-44	18
E9-48	22



## Filter Element

# HIROSS

Model	Precision	New model
024	Q	3283006145Q
024	P	3283006145P
024	S	3283006145S
035	Q	3283006215Q
035	P	3283006215P
035	S	3283006215S
060	Q	3283006362Q
060	P	3283006362P
060	S	3283006362S
090	Q	3283008382Q
090	P	3283008382P
090	S	3283008382S
150	Q	3283008760Q
150	P	3283008760P
150	S	3283008760S
240	Q	3283210950Q
240	P	3283210950P
240	S	3283210950S
120	Q	3283008610Q
120	P	3283008610P
120	S	3283008610S
015	Q	3283004142Q
015	P	3283004142P
015	S	3283004142S
007	Q	3283004118Q
007	P	3283004118P
007	S	3283004118S
004	Q	3283004068Q





Filter  
Element

# Domnick Hunter

Model	Precision	New model
K017	AO	3283004080AO
K017	AA	3283004080AA
K220	AO	3283008333AO
K220	AA	3283008333AA
K220	AX	3283008333AX
K220	ACS	3283008333ACS
K430	AO	3283011415AO
K430	AA	3283011415AA
K430	AX	3283011415AX
K620	AO	3283011634AO
K620	AA	3283011634AA
K620	AX	3283011634AX
K145	AO	3283007260AO
K145	AA	3283007260AA
K145	PF	3283007260PF
K145	ACS	3283007260ACS
K058	AO	3283007160AO
K058	AA	3283007160AA
K058	AX	3283007160AX
K058	ACS	3283007160ACS
K058	PF	3283007160PF
K030	AO	3283004120AO
K030	AA	3283004120AA
K330	AO	3283008635AO
K330	AA	3283008635AA
K330	AX	3283008635AX



## Air-water Separator

AW improves the performance compared with traditional separator

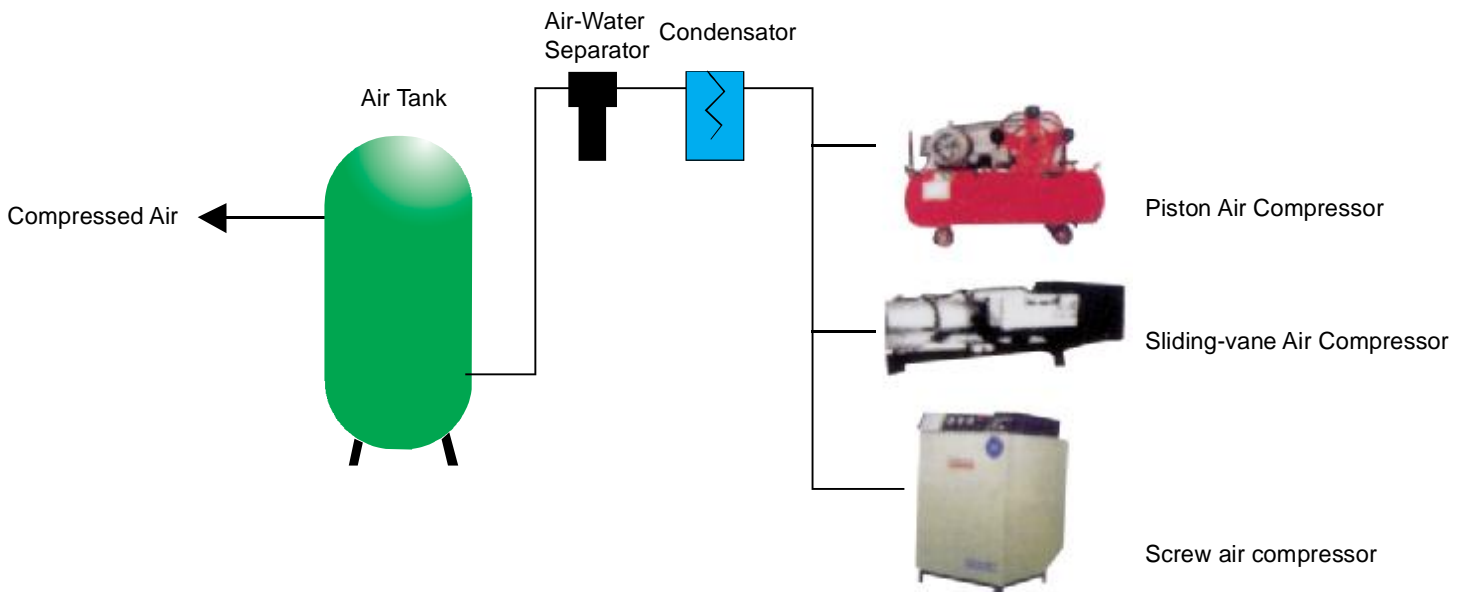
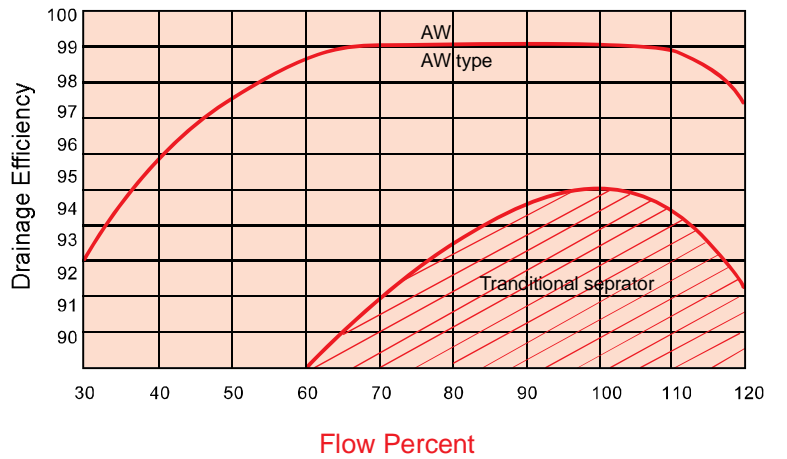

Example of application

Removal the moisture in the compressed air is the main task for compressed air clean .

The water with the impurities in the compressed air will corrode the pipe, valve, gauge and equipments. also cause increase of production cost.

Gravitation theory and collision mechanism can effectively eliminate the liquid water in the compressed air . Aluminum alloy air water separator is small and compact . And it also wears well.

The loss of pressure is small .The imported automatic blow off valve is equipped in it.

It isn't necessary to replace the element. It is not only the perfect element of the screw compressor, but also is the necessary after treatment water removal device of the ordinary air compressor.

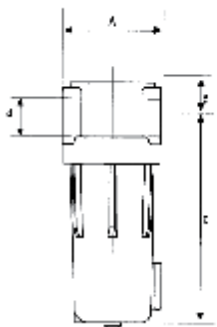
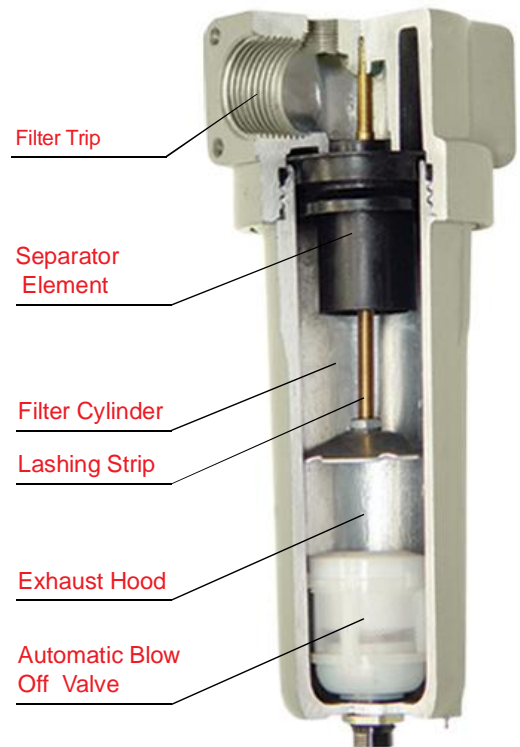

fig1

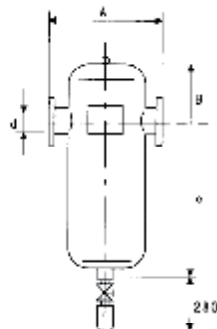

fig2

Max working pressure: 1.6Mpa  
 Water separating efficiency ≥ 99%  
 Max working temperature: 66°C

Type 1: fig 1 Aluminum alloy casting, built-in automatic draining valve  
 Type 2: fig 2 Carbon steel casting, external automatic draining valve (optional)

Model	Fig	Nominal Flow Rate m <sup>3</sup> /min(0.7Mpa)	Intet/Outlet connection port	Overall Dimensions(mm)			Material
				A	B	C	
AW0150	1	1.5-2.4	G 1/2	89	26	166	Alu.Alloy
AW0216	1	2.5~3.6	G 3/4	89	26	166	
AW0270	1	3.7~5.4	G1	89	26	166	
AW0270A	1	3.7~5.4	M33 x 2	89	26	166	
AW0450	1	5.5~8.6	G1 1/4	120	41	256	
AW0540	1	8.7~13	G1 1/2	120	41	256	
AW1200	1	14~29	G2	160	51	413	
AW1200A	1	14~29	M60 x 2	160	51	413	
AW2400	1	30~40	G2 1/2	216	65	660	Aluminum Filter Trip Stainless Filter Cylinder
AW3000	1	41~50	G3	216	65	750	
AW2520	2	30~42	DN80	450	180	620	Steel
AW3300	2	43~55	DN100	510	210	660	
AW4080	2	56~68	DN125	580	280	830	
AW4800	2	69~80	DN150	750	300	910	

## Advantage



### Robot Welding

Hitachi Robot Welding  
Insure high quality & precision



### Assemble Line

Introduced Air Conditioner Production  
line Improve lead time.



### Famous brand Compressor

Hitachi, Panasonic, Mitsui-Seiki

## Alu.Alloy Pipeline Filter



### Diagram 1

1-7.6m<sup>3</sup>/min

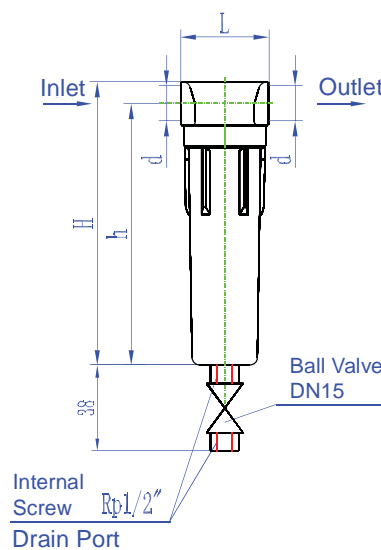

### Diagram 2

11-24m<sup>3</sup>/min

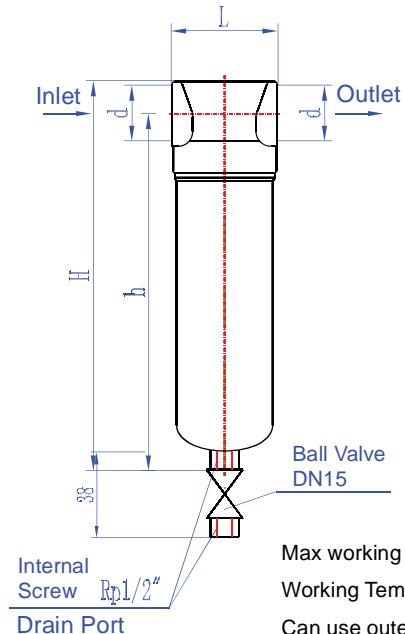

Max working pressure: 1.0MPa  
Working Temperature: 1.5-65°C  
Can use outer Auto-drain

# Pipeline Filter

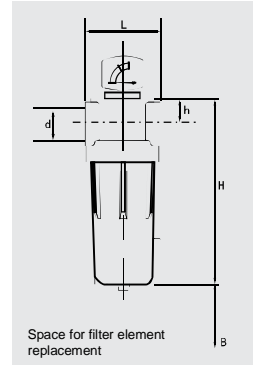
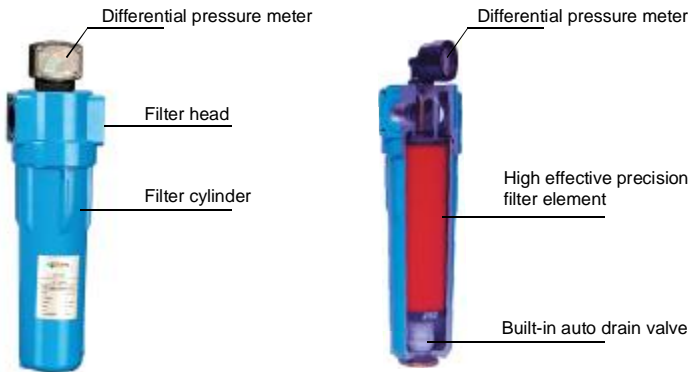

Max working pressure: 1.6MPa

Working temperature: 1.5-65°C

Built-in auto drain valve

Model	Grade	Flow Rate	Dimension					Filter Element		Weight kg
			d	L	h	H	B	Qty	Code	
AM0060- *- #	V	1	Rp 1/2	89	26	231	126	1	M 010- *	0.95
AM0090- *- #		1.5	Rp 3/4	89	26	231	131	1	M 015- *	1.15
AM0216- *- #		3.6	Rp1	120	40	299	170	1	M 036- *	2.75
AM0288- *- #		4.8	Rp1 1/2	120	40	399	210	1	M 048- *	3.25
AM0432- *- #	A	7.2	Rp1 1/2	120	40	399	270	1	M 072- *	3.3
AM0522- *- #		8.7	Rp1 1/2	120	40	399	270	1	M 087- *	3.3
AM0720- *- #	B	12	Rp2	160	50	463	320	1	M 120- *	5.9
AM0960- *- #		16	Rp2	160	51	663	420	1	M 160- *	9.8
AM1200- *- #		20	Rp2	160	51	863	620	1	M 200- *	13
AM1440- *- #	C	24	Rp2 1/2	216	65	660	420	1	M 240- *	16.2
AM1920- *- #		32	Rp3	216	65	750	520	1	M 320- *	22
AM2400- *- #		40	Rp3	216	65	620	620	1	M 400- *	25

Notes: 1. \* Stands for grades

2. Stainless steel cylinder for flow rate 16-40m<sup>3</sup> filters

3. Please contact us for information of sterile filters (Grade D)

4. Dimensions subject to change without notice.

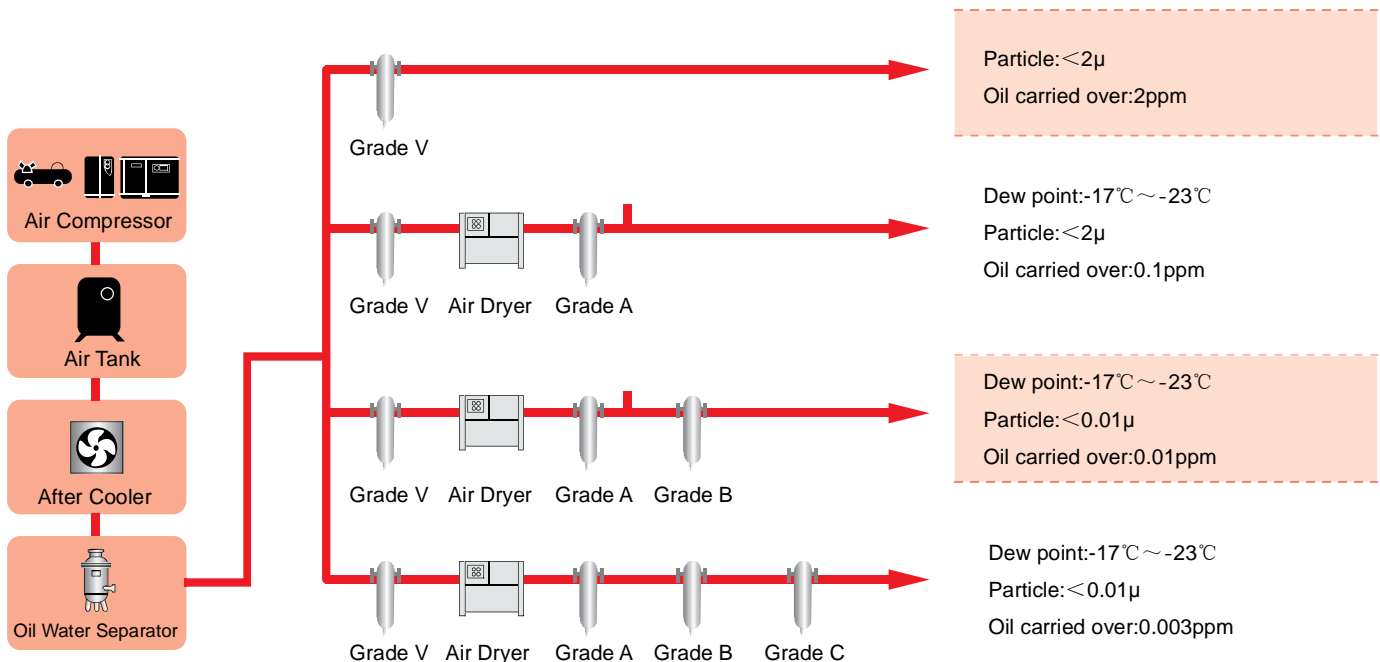





**Shanghai Thenow Technologies Co.,Ltd.**

---

Shanghai Thenow Technologies Co.,Ltd.

Add: No.358 Xinqin Rd.,Nanxiang Town, Jiading District, Shanghai, China

Zip Code: 201802

Tel: +86 21 5108 2108

Fax: +86 21 66613500

Mail:[info@thenow.cn](mailto:info@thenow.cn)

[WWW.THENOWGROUP.NET](http://WWW.THENOWGROUP.NET)